



Glass Mounting Kit for IPORT Surface Mount

Product Code: SO-70720

Surface Mount Glass Mounting Kit Best Practices

Best Practices:

- Clean glass surface with alcohol and dry before applying adhesive strips
- Avoid adhering to frosted glass
- Avoid ambient temperatures exceeding 40° C for long periods of time
- Apply pressure to entire assembly for at least 2 minutes when Applying to glass
- Ensure entire surface area of adhesive is bonded with glass before applying vinyl backing (can determine by looking behind glass inside of conference room and citing any gaps)
- If needed, utilize additional adhesion strips in the box for additional bond.



Included in the IPORT Glass Mounting Kit Surface - 3 different size Covers + Adhesive strips

Large Cover 360mm x 240mm



Adhesive Side



Cover Side

Included in the IPORT Glass Mounting Kit Surface - 3 different size Covers + Adhesive strips

Medium Cover 270mm x 170mm

Adhesive Side

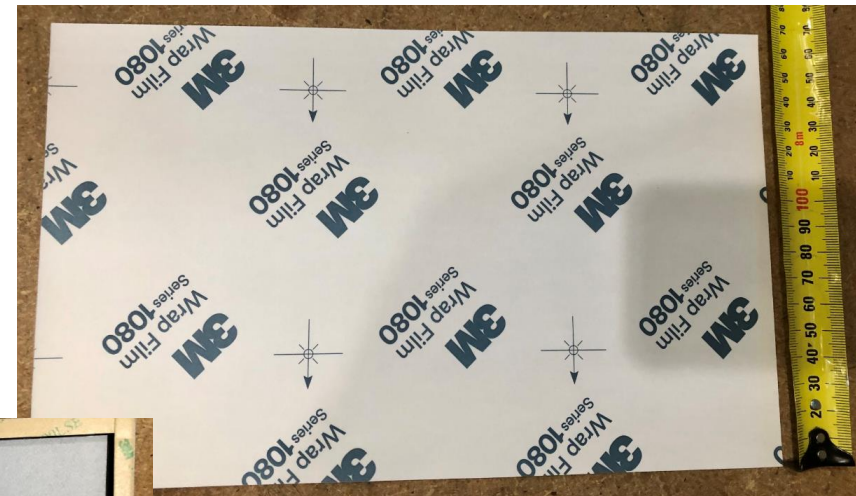

Included in the IPORT Glass Mounting Kit Surface - 3 different size Covers + Adhesive strips

Small Cover 235mm x 135mm

Adhesive Side

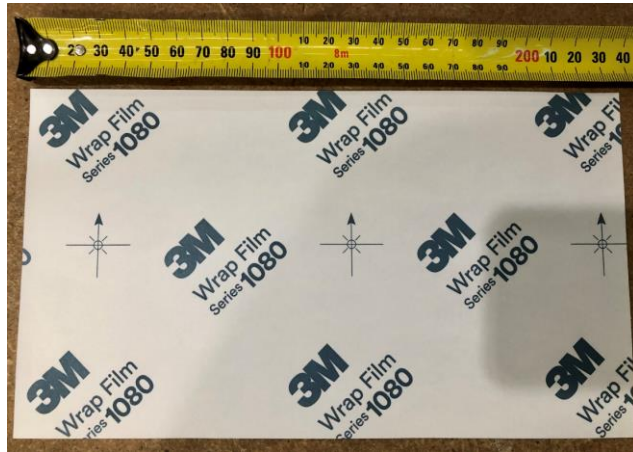



3 x different sized
Covers with adhesive
sitting in on the
edges.

**Adding Additional Adhesion Strips to
Surface Mount - Mounting Bracket**



If needed, utilize additional
adhesion strips in the box for
additional bond



Default Strips



Additional Strips

Step 1

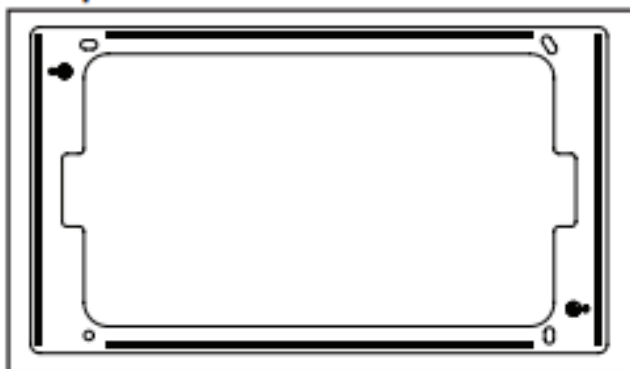

Adhere the adhesive strips on the back of the Surface Mount bracket as shown.

Step 2

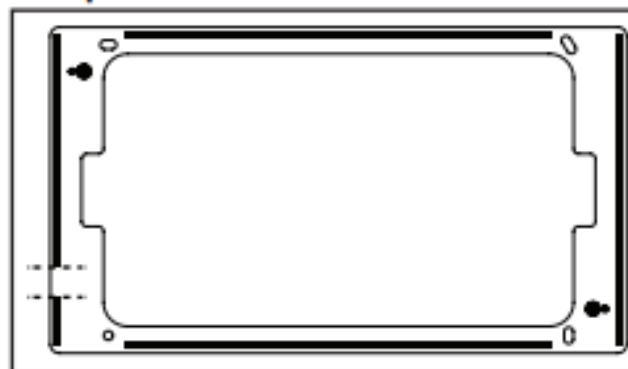

Cut a piece of the adhesive strip where the lightning cable will route behind Surface Mount.

Step 3

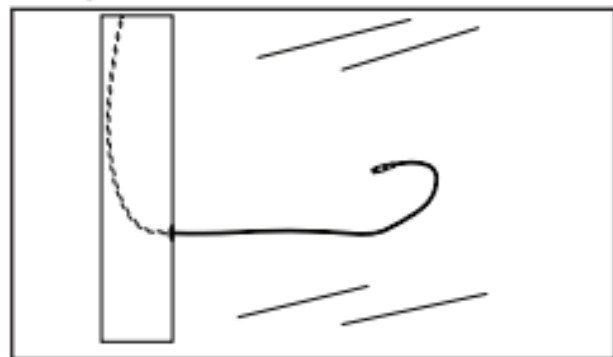

Drill a 3/8" small hole and route the cable down the aluminum channel and out the hole. Make sure there is enough length.

Step 4

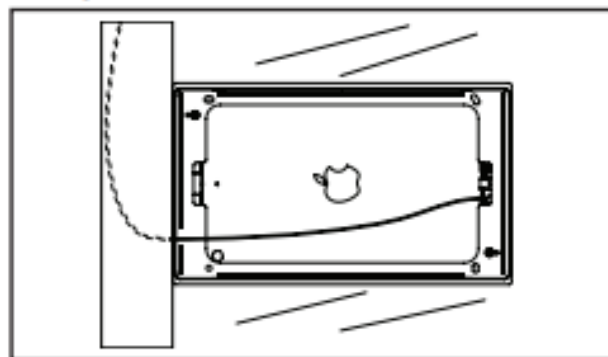

Connect the iPad and place it in the bezel. Attach the bezel to the bracket. Adhere the Surface Mount bracket to the glass close to the channel.

Step 5

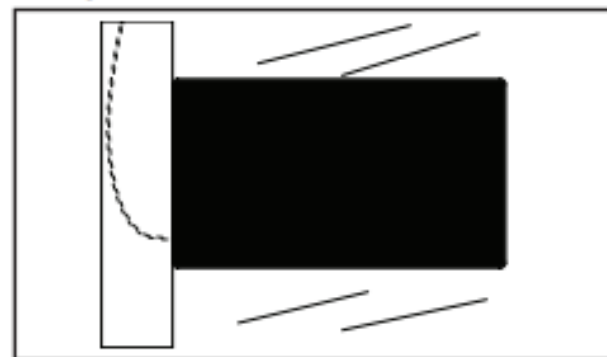

Adhere the backing label to the opposite side of the glass to hide the back of the Surface Mount and iPad.

IPOINT Surface Mount to Suit Mini 4 & 5 Bezel

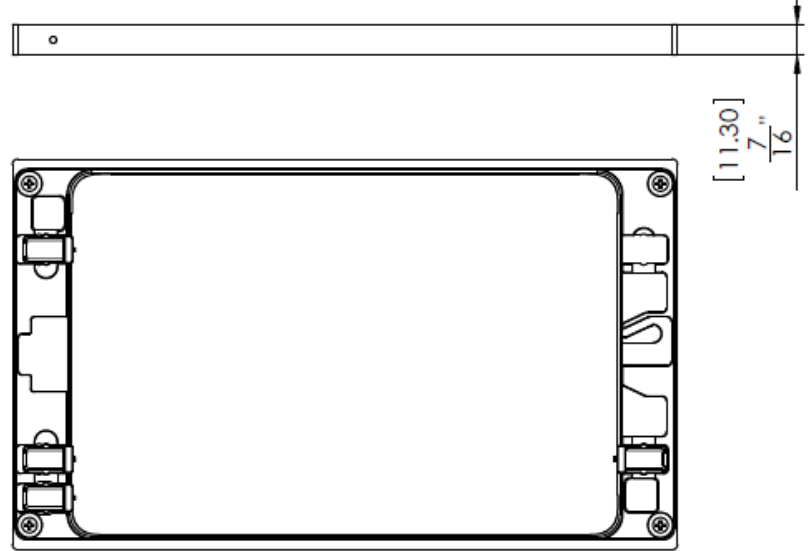
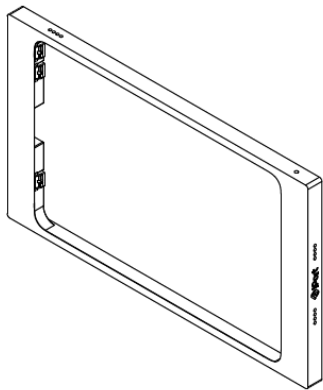
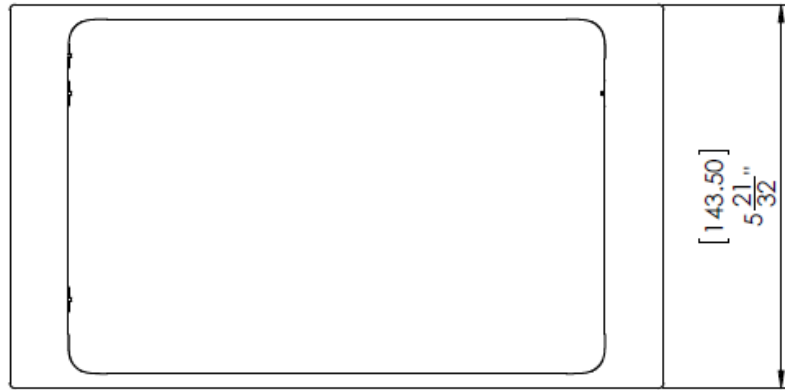
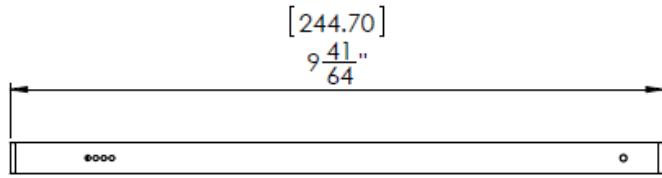

IPOINT Surface Mount to Suit 10.2" Gen 8 & 7

